

The image features a close-up, diagonal view of wood-grain cladding panels. The panels are arranged in a staggered pattern, creating a sense of depth and texture. The wood grain is a warm, medium-brown color with visible natural patterns. A horizontal white band runs across the center of the image, serving as a background for the text.

DUROWOOD

www.durowood.com

WOODX CLADDING SERIES

DUROWOOD WOODX Cladding



Drawing	Photo	Model	Size(mm)
		DW-011	5.5×0.5 inch(140×13mm)
		DW-3048	3×3 inch(72×72mm)
		DW-3047	4×1.5 inch(99×28.5mm)
		DW-3046	3×4 inch(67×47.5mm)

Joist

We recommend for the under construction aluminum or pressure treated wood joists. Each cladding board needs to be supported by a joist no more than 20"(500MM) from center to center. Extra care is required in order to provide sufficient joisting in and around obstacles such as windows, fascia's soffits, guttering, ventilation points etc. Below is an example of the layers that would occur in a typical installation, but a licensed professional should always be consulted prior to any installation.

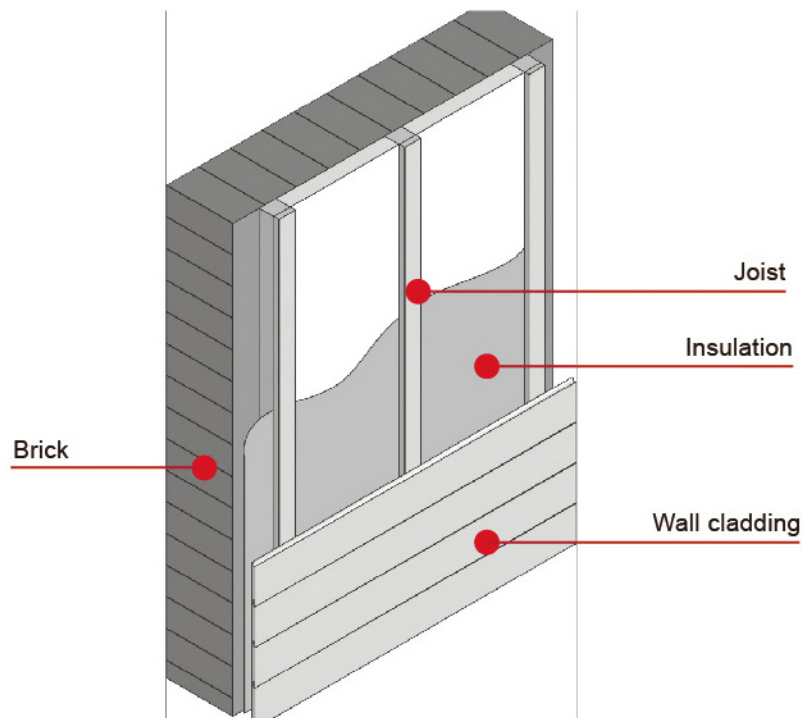

Joist Installation

Please consult a professional building professional to design and choose the correct drainage and ventilation duct materials and design layout. The thickness of the keel is at least 25MM, so that there is sufficient open and dry space between the wallboard and the wall and not blocked by the ventilation ducts. The wall of the construction must be horizontal, and the center distance between the keels cannot exceed 500MM.

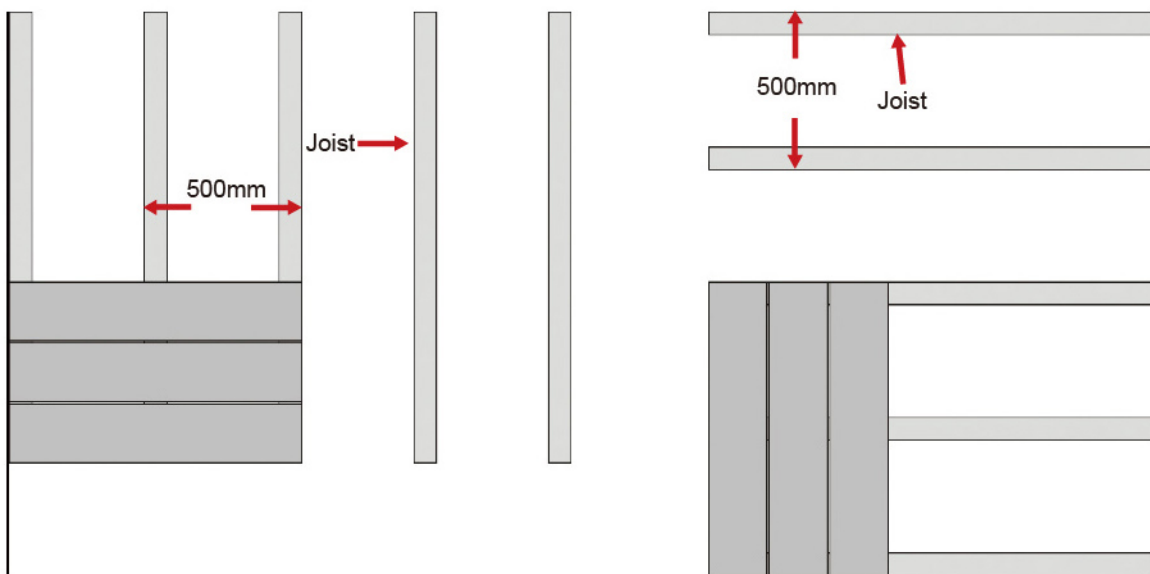

● Horizontal Installation

● Vertical Installation

The wall cladding fastener

Each wall board clip has screw holes to fix the wall board, so that the wall board shrinks in the specified direction to avoid warping and deformation. As shown in Figures 1,2,3.

Notice: When wall panel splicing is required, it is recommended to use the matching edge banding DW3047 for installation.

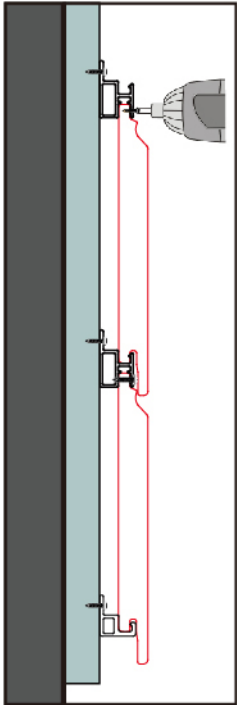

Figure 1

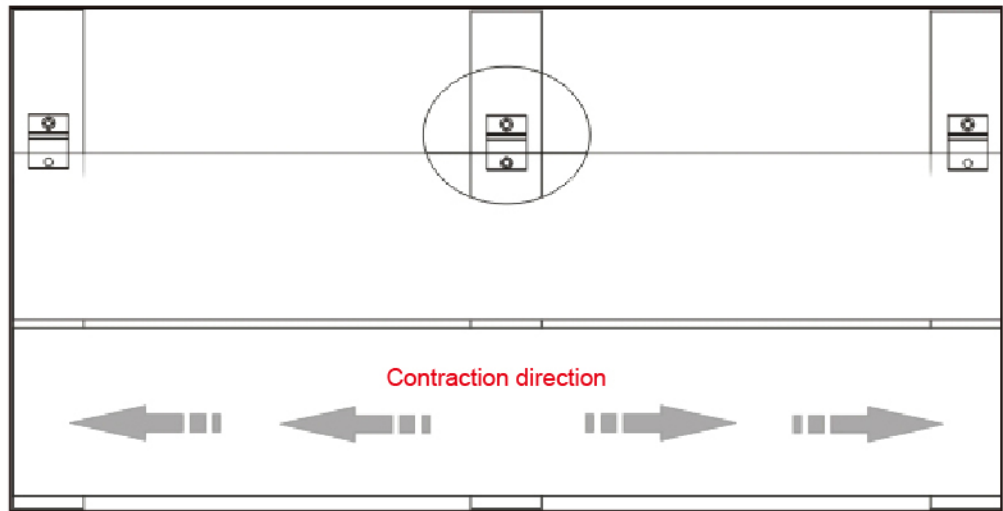

Figure 2

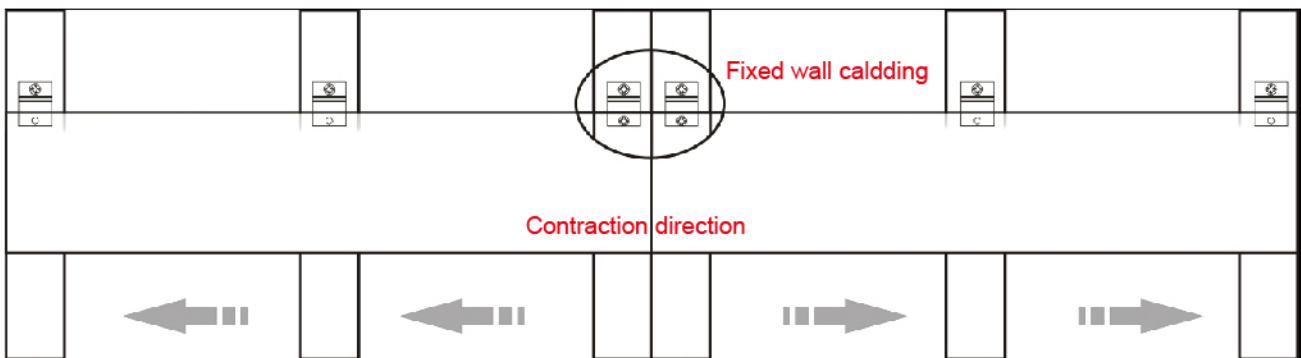
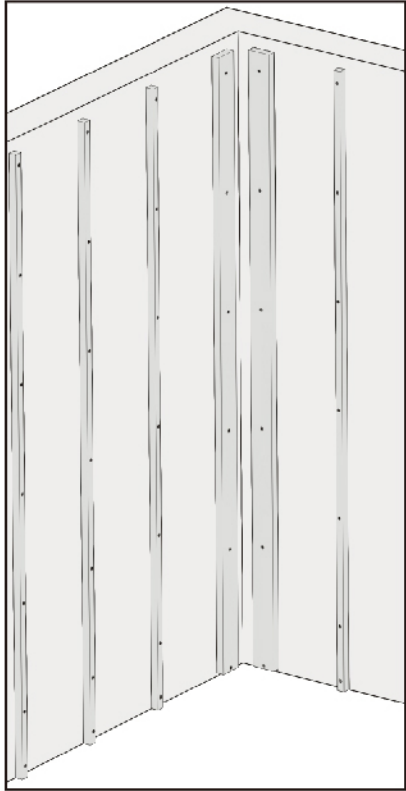
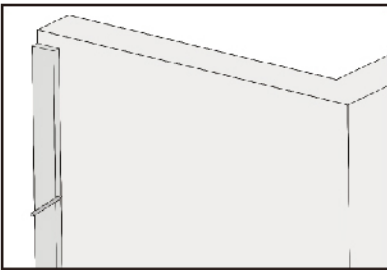
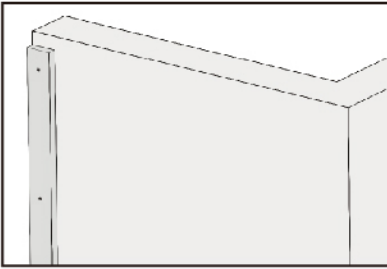
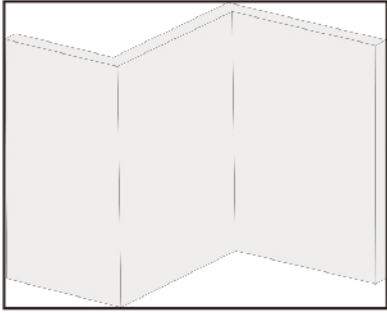

Figure 3

Fixed Joist



● Fixed start joist

- Determine the position of the second keel according to the requirements of the middle distance of the keel. As shown in the figure, the schematic diagram after the keel is installed.

DW011 wall cladding installation

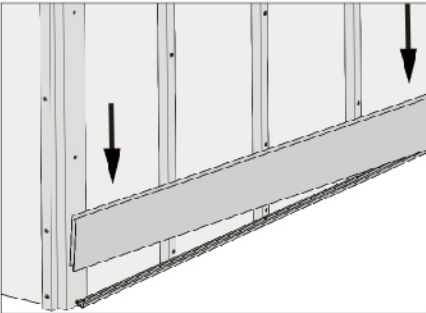

- As shown in the figure, slide the wall panel down to the starter clip.

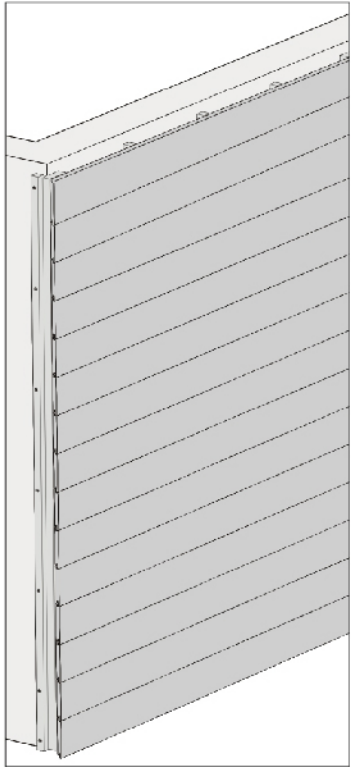
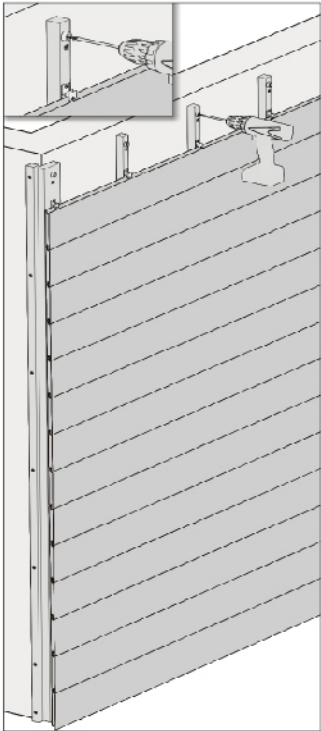
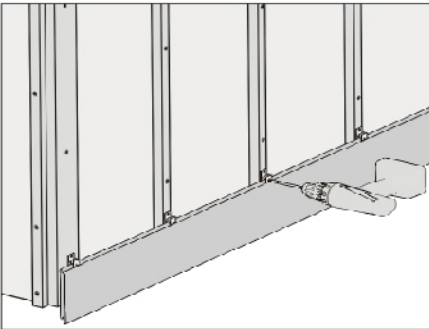

Note: The bottom wall panel is at least 10MM away from the ground to ensure that the wall is dry and ventilated.

- As shown in the figure, when installing to the last wall panel at the top, first install the plastic pad round base pad on each keel before installing the wall panel.
- As shown in the figure, for the effect of installation

Corner edge DW3048 installation

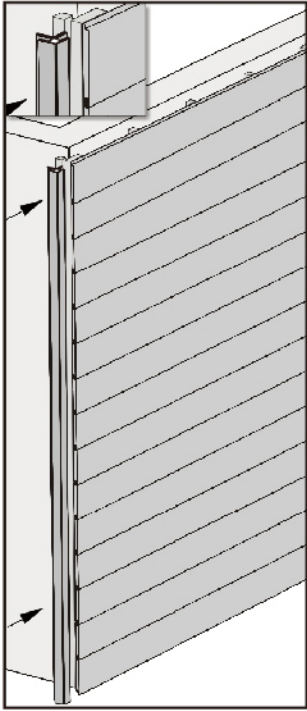

- Install edge seal DW3048 at the outer corner as shown.

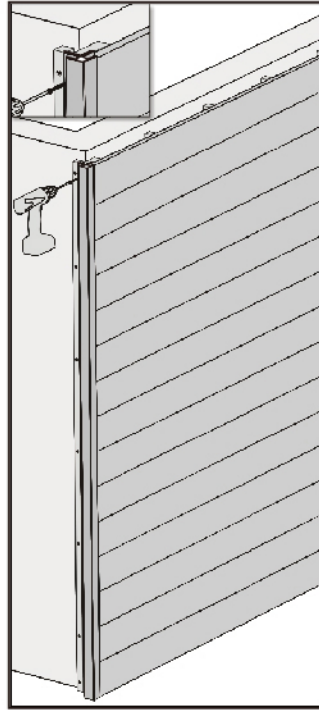

- As shown in the figure, fix the cover DW3048 with screw.

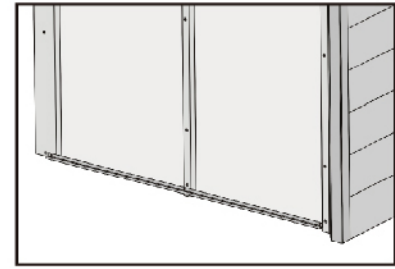
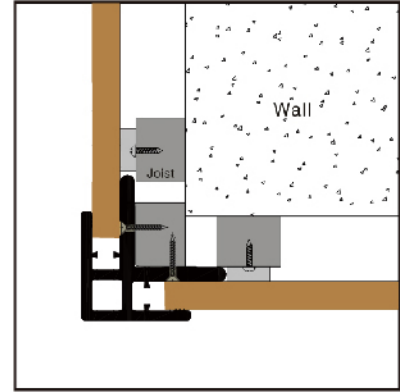

✘ Note: Be sure to pre-drill and fix the nail first. The distance between the screw holes should not exceed 300MM.

End cover DW3046 installation

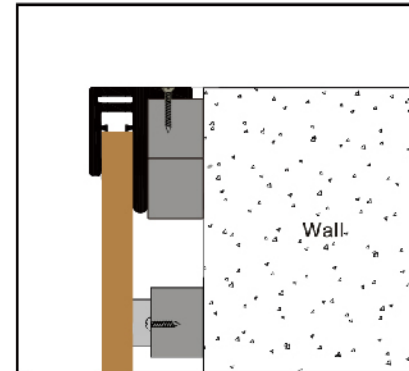
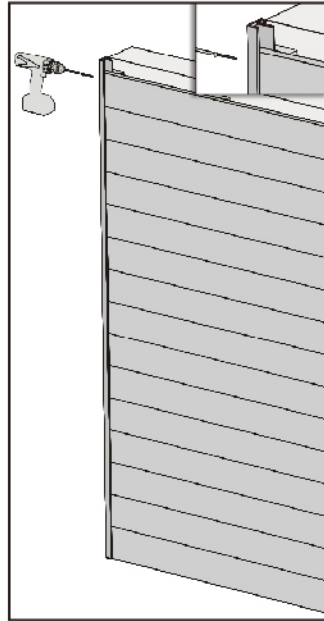
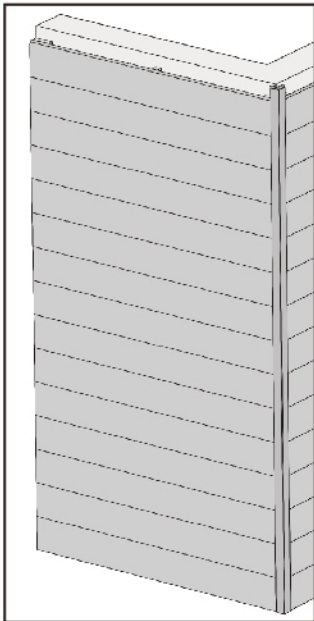

- After installing the wall cladding, then fix DW3046

✘ Note: When fixing DW3046, the screws must be pre-drilled, and then drilled into the wall cladding at a right angle of 90 degrees. Do not drill the screws at an angle without pre-drilling.

Connection cover DW3047 installation

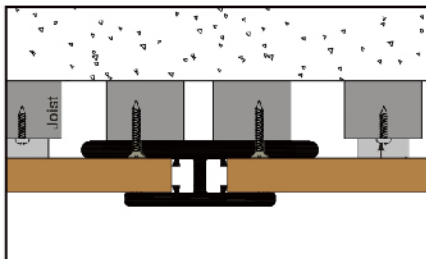
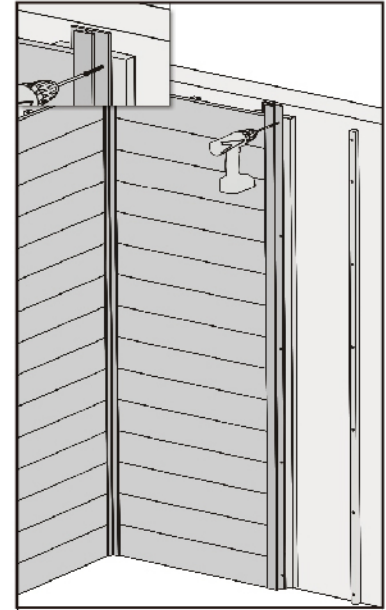
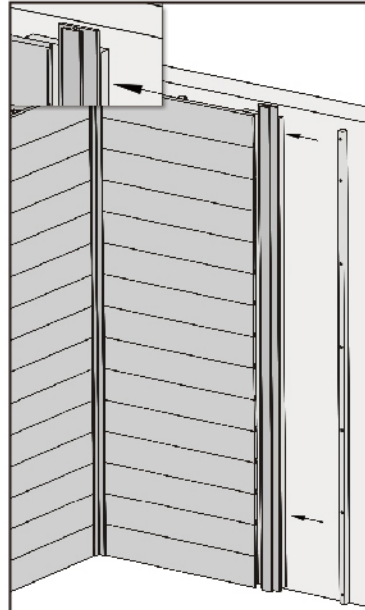
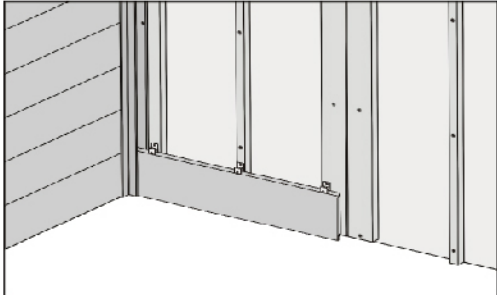
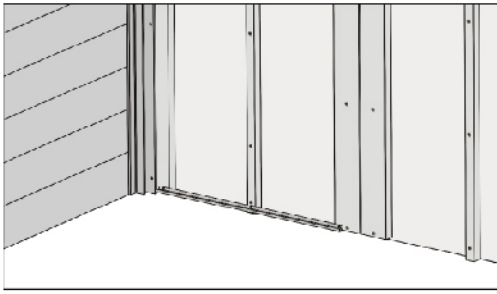

- This installation guide is to install the wall plate DW011 first, then install the I-shaped edge DW011 at the wall panel splicing place. If the construction drawing has planned the wall panel splicing place in advance, you can also install I-shaped edge DW3047 first, then install the wall cladding DW011.

⊗ Note: The bottom wall panel is at least 10MM away from the ground to ensure that the wall is dry and ventilated. Be sure to pre-drill and fix the nail first. The distance between the screw holes should not exceed 300MM.

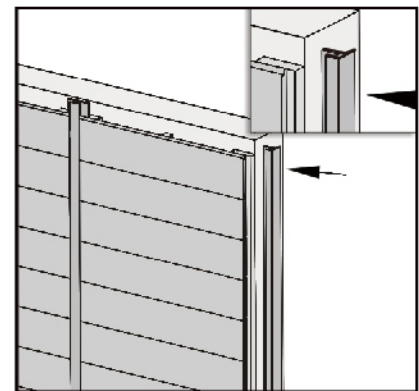
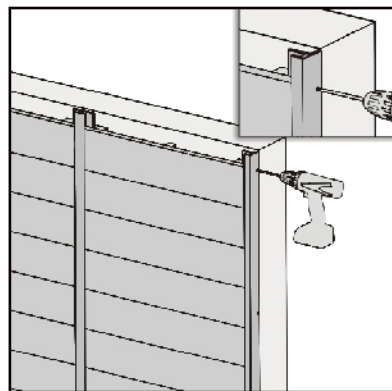
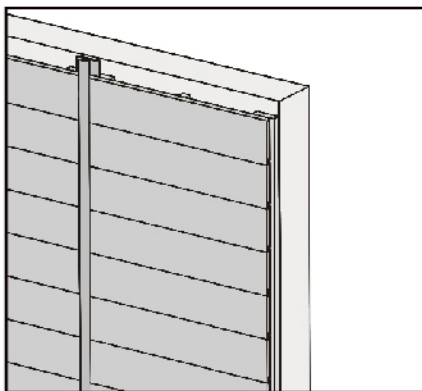

⊗ Note: Be sure to pre-drill and fix the nail first. The distance between the screw holes should not exceed 300MM.

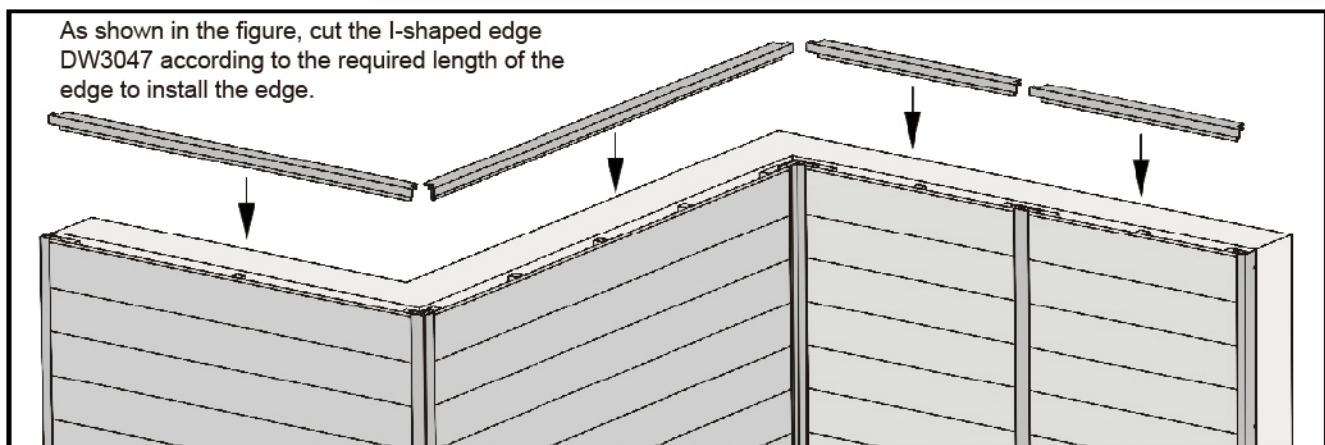

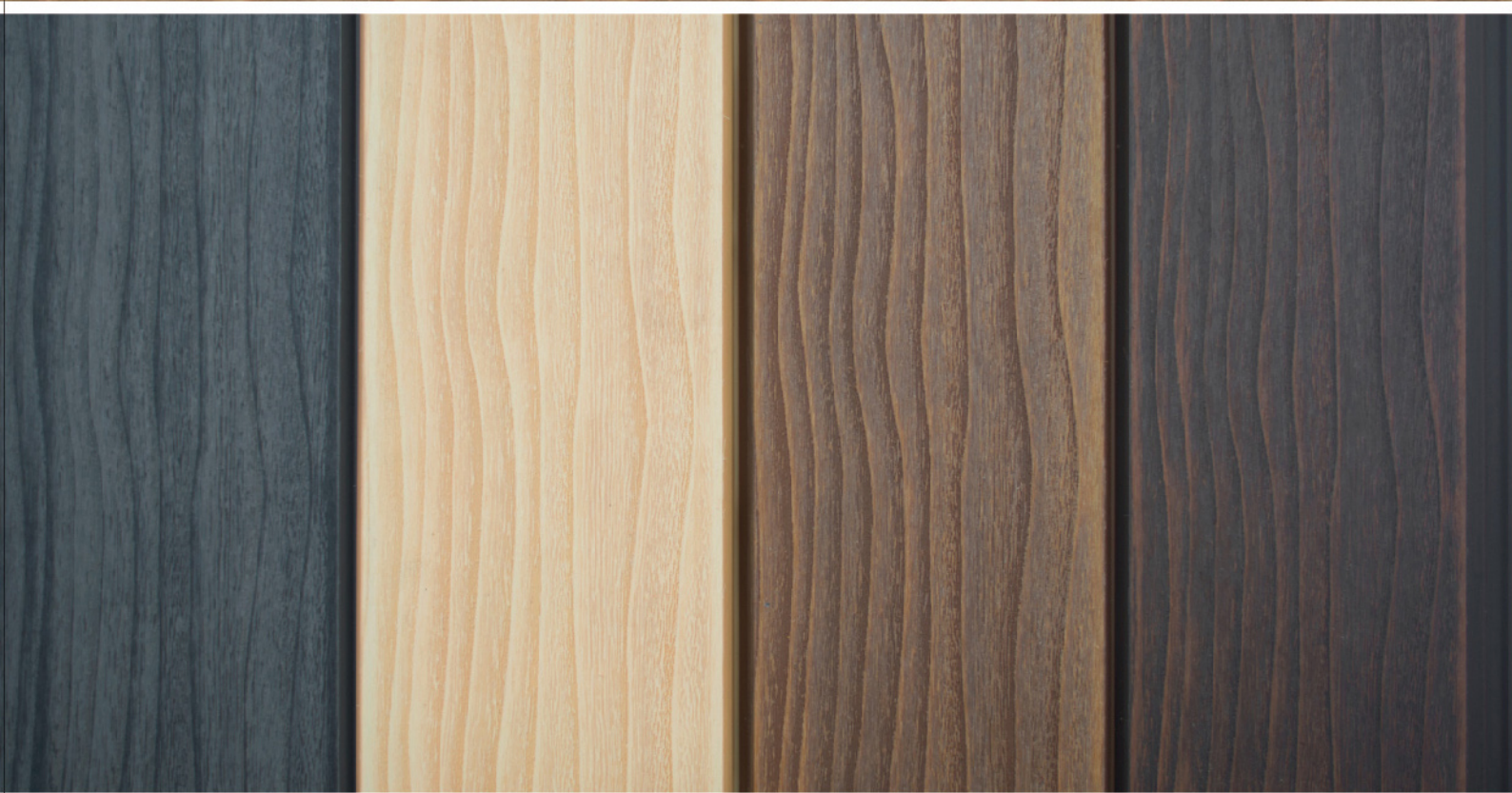

DUROWOOD
www.durowood.com